

# Łazienka CLASSIC

## Szafka niska 1D

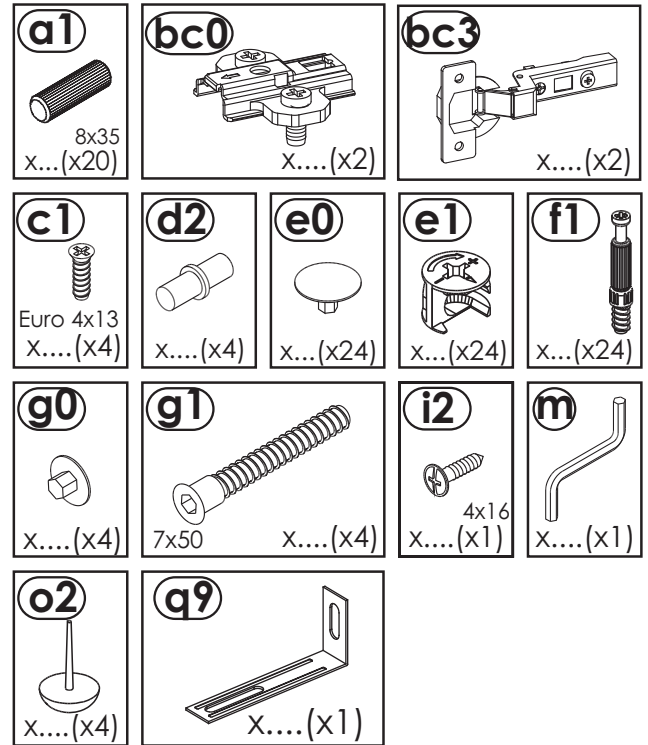

Schemat montażu nie jest dokumentacją techniczną. Producent zastrzega sobie możliwość zmian konstrukcyjnych.

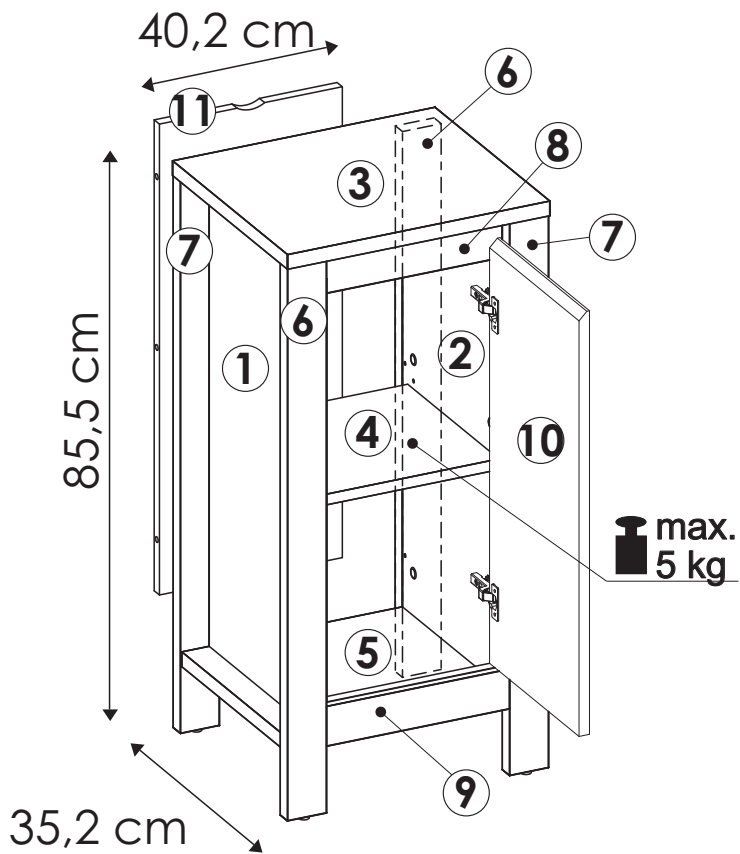
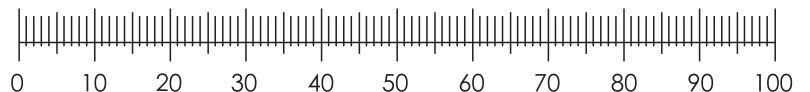
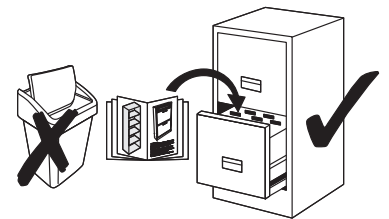
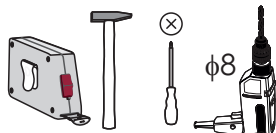
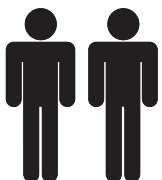

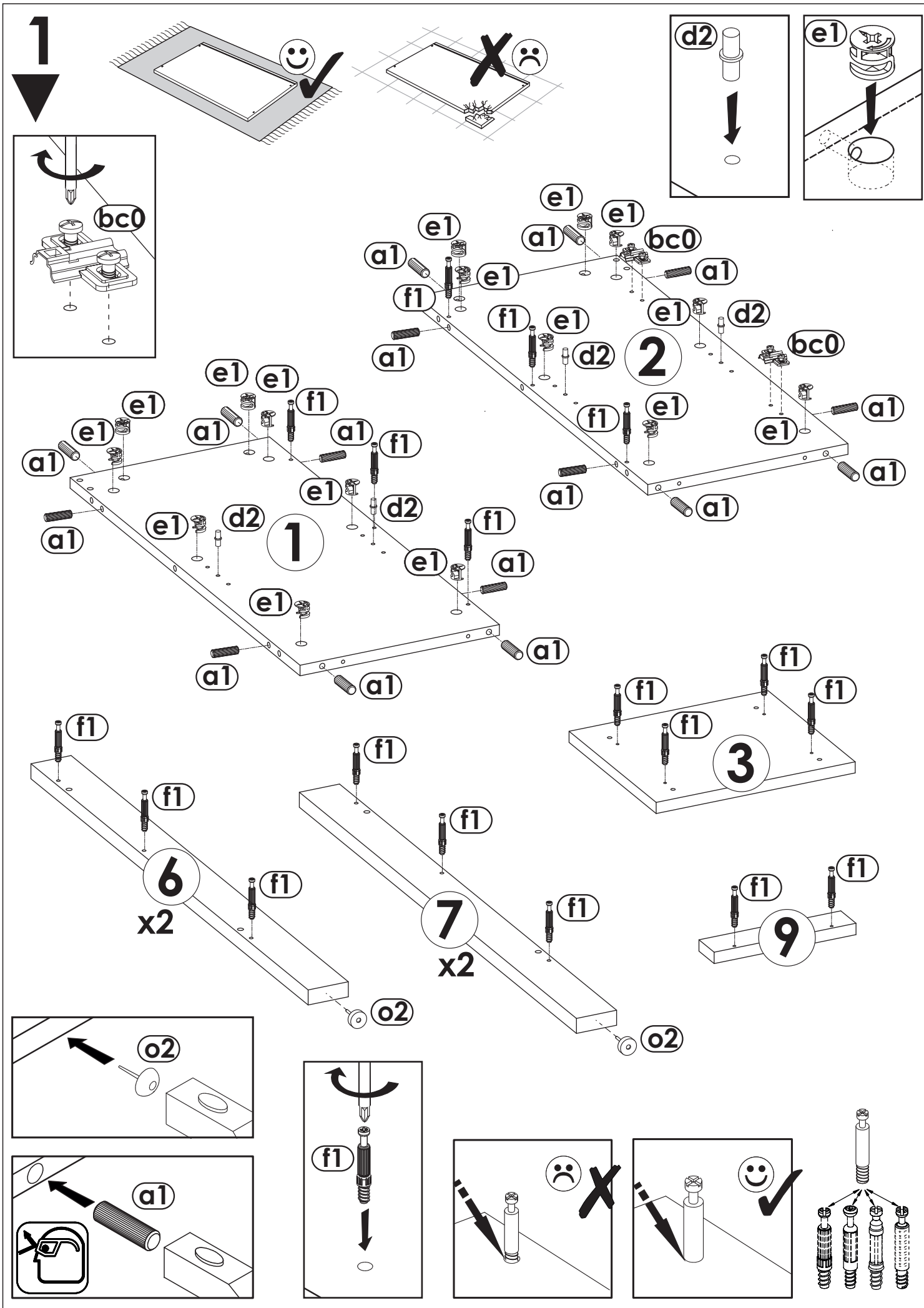

2

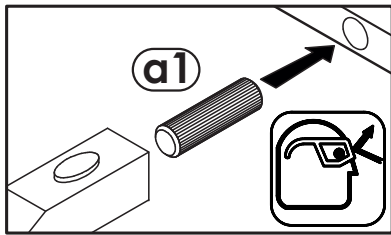
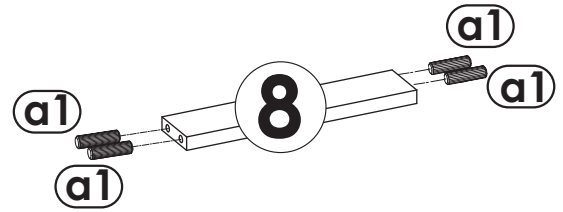
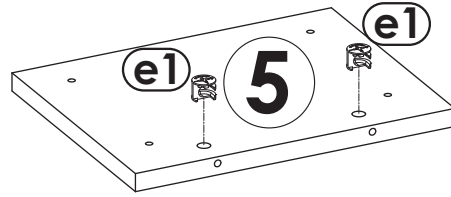
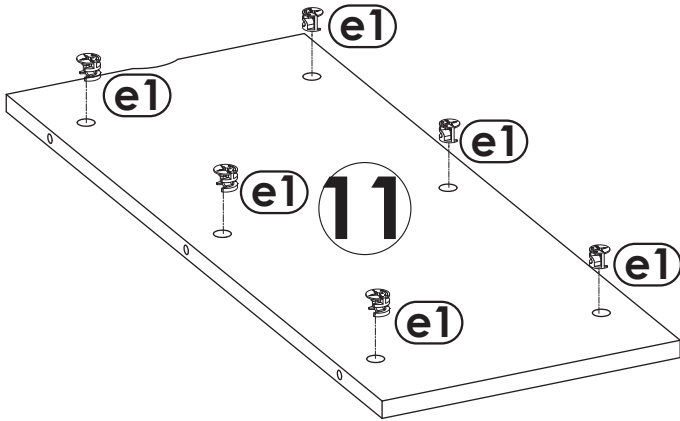
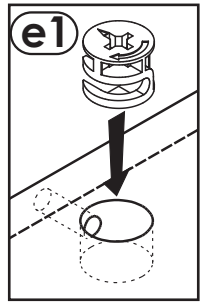
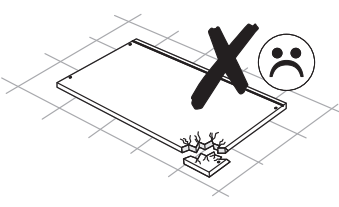
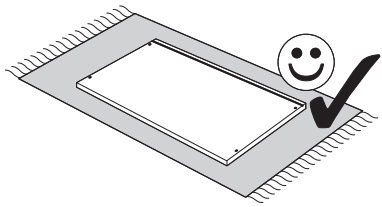

3

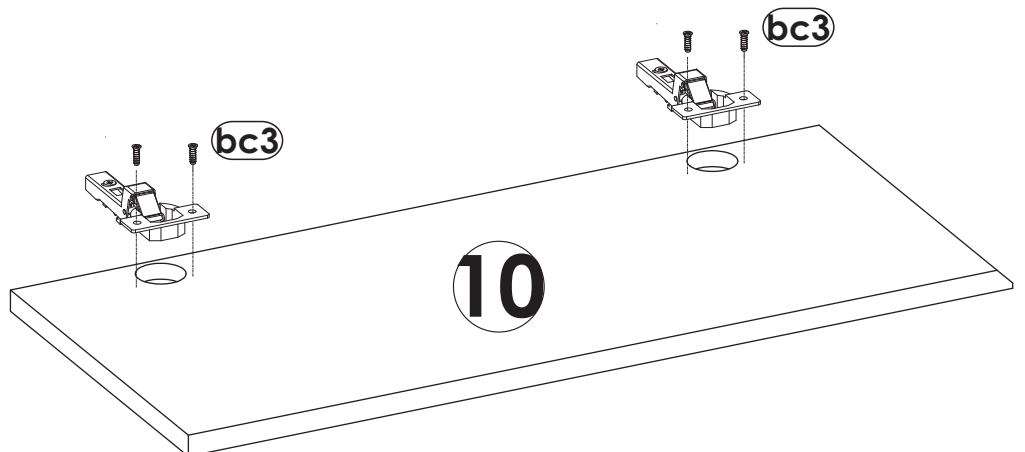
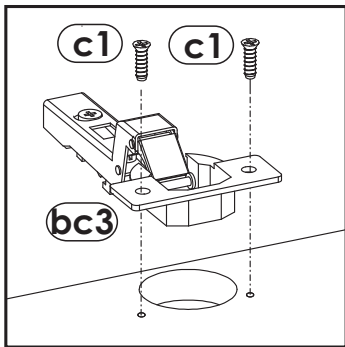
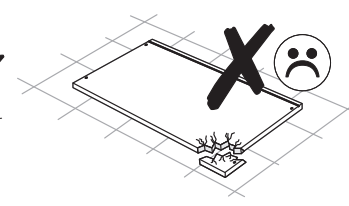
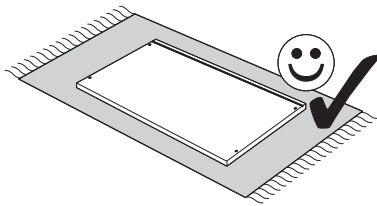
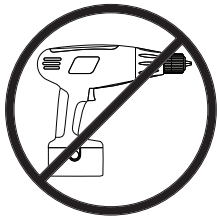

4  
▼

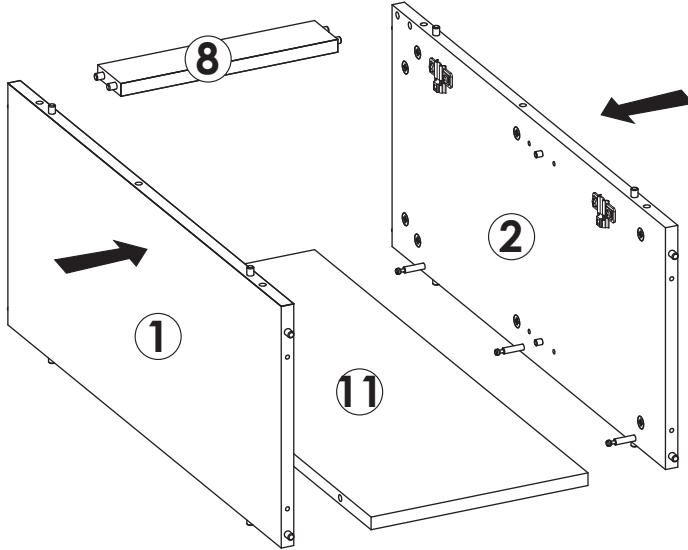
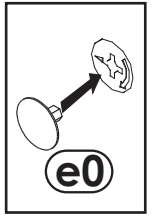
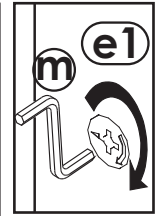
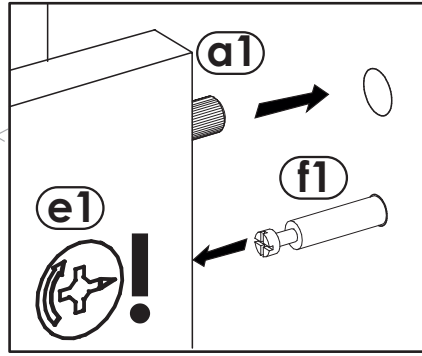
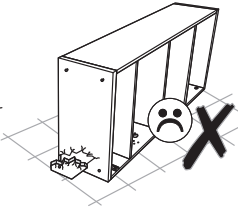
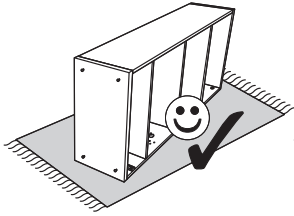

5  
▼

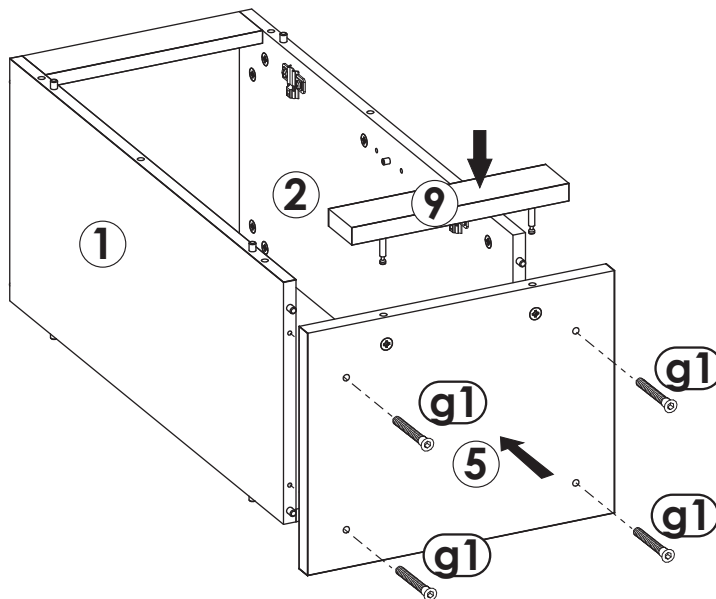
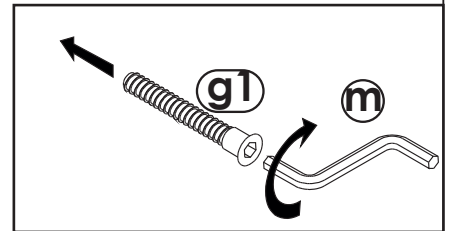
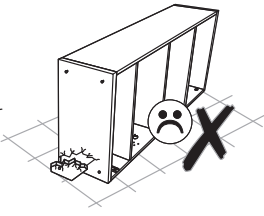
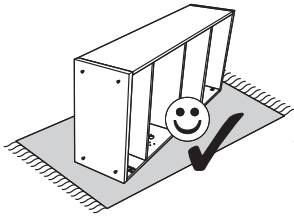

6

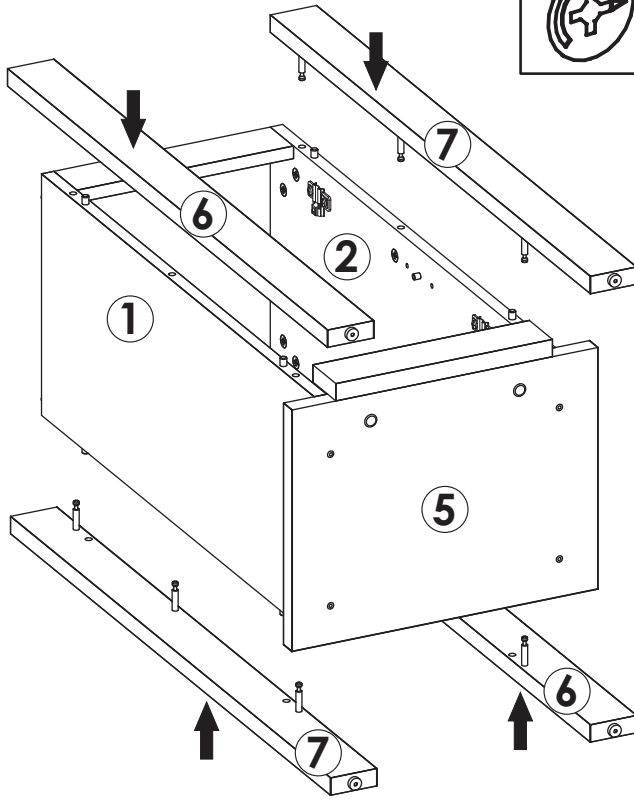
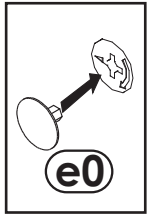
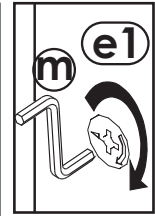
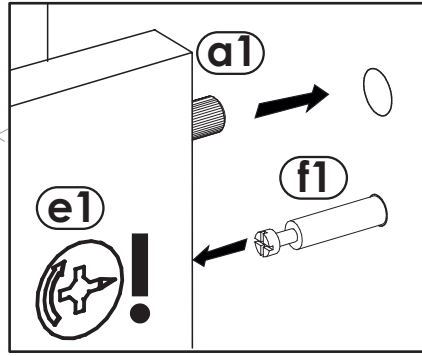
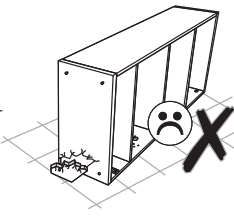
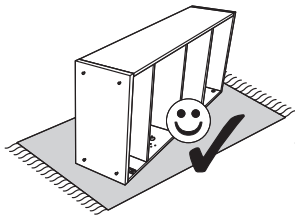

7

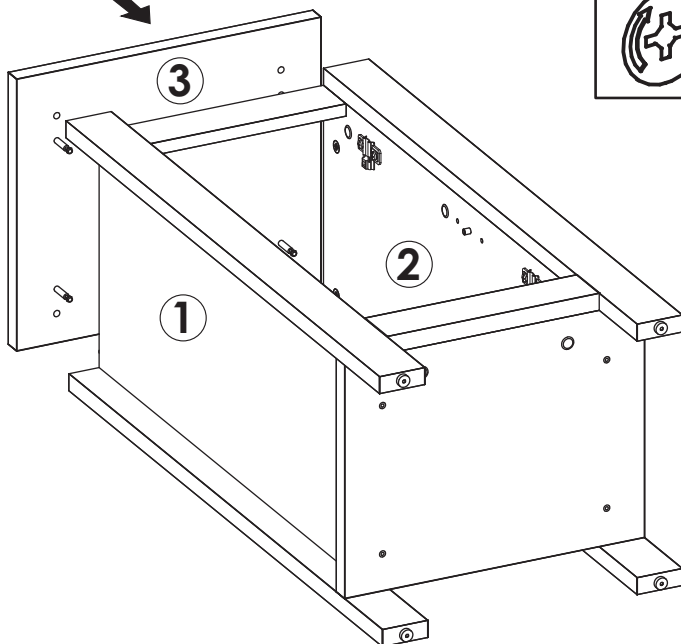
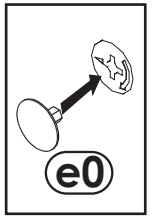
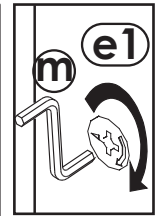
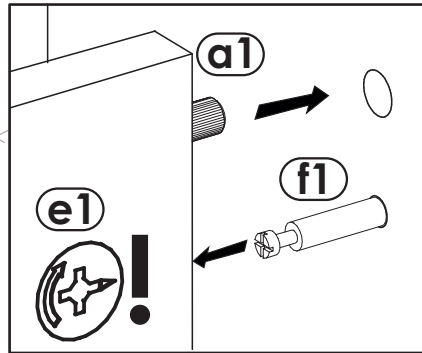
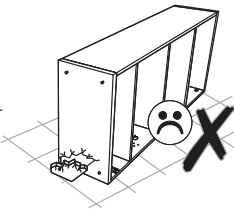
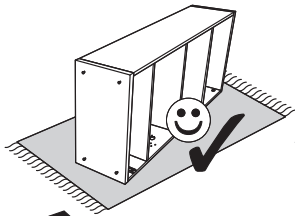

8

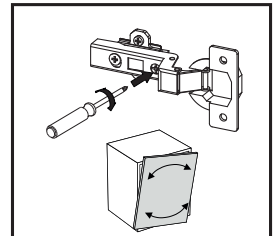
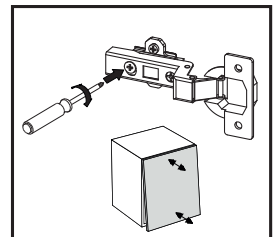
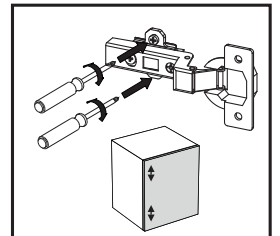
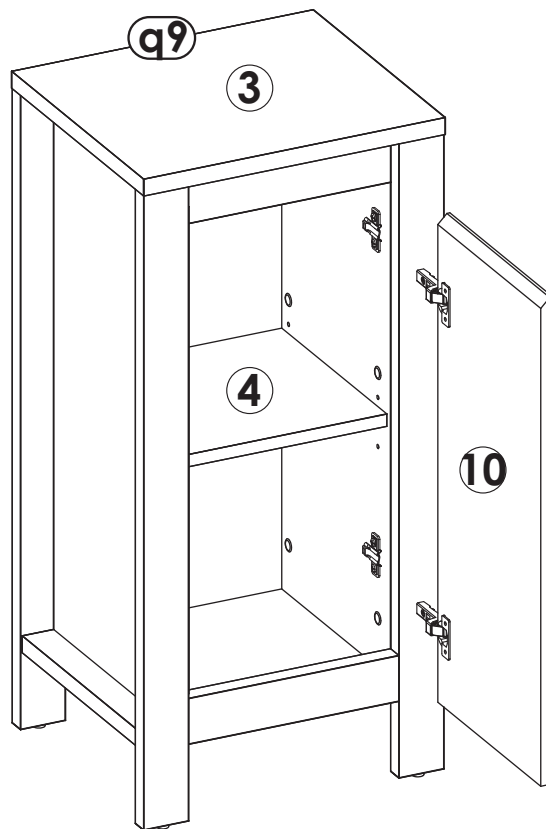
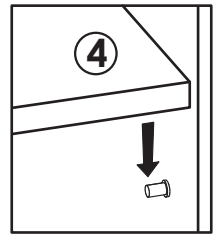
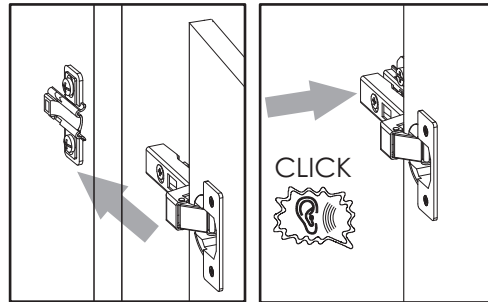
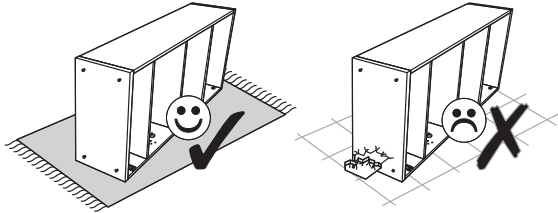

**UWAGA!**

- \* Należy zaopatrzyć się w kołki i wkręty dobrane odpowiednio do rodzaju ściany
- \* Elementy te nie wchodzą w skład okuć!!!

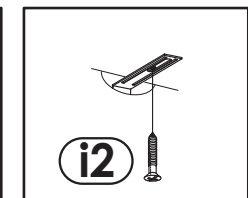
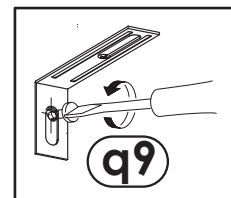
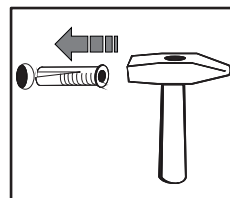
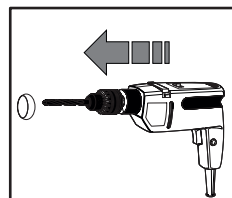
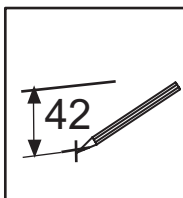
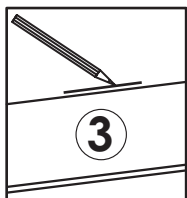



# Uwaga !

## Zasady użytkowania i konserwacji mebla.

- 1. Mebel powinien być użytkowany zgodnie z jego przeznaczeniem-w pomieszczeniach zamkniętych i zabezpieczonych przed działaniem warunków atmosferycznych.**
- 2. Montaż wyrobu musi być wykonany zgodnie z załączoną instrukcją.**
- 3. Wyrób nie może mieć zastosowania w saunie.**
- 4. Mebel wykonany jest z płyty drewnopochodnej, należy chronić go przed bezpośrednim i długotrwałym kontaktem z wodą (w szczególności przed zalaniem), oraz przed wysoką temperaturą (np. odparzenia ).  
Wilgoć może wnikać w materiał mebla i uszkodzić go.**
- 5. Do czyszczenia powierzchni należy stosować lekko wilgotną, miękką tkaninę, następnie wytrzeć do sucha.**
- 6. W przypadku powstania silniejszych zabrudzeń można użyć łagodnych środków myjących przeznaczonych do czyszczenia mebli.**
- 7. Nie należy używać do czyszczenia aktywnych środków chemicznych (np. usuwających kamień, rdzę, środków do czyszczenia ceramiki itp.).**
- 8. Za uszkodzenia powstałe w wyniku niestosowania się do powyższych zaleceń producent nie ponosi odpowiedzialności.**